

GDZW7-ECO Z-Wave®

Long Range Garage Door Controller



Installation Instructions and User Manual
(Scan QR Code for online content.)



Specifications

Operating Frequency:	Z-Wave Long Range (912MHz, 920MHz), Z-Wave (908.42MHz, 916MHz), 310MHz, 315MHz, 345MHz, 390MHz
Operating Temperature:	-4° – 140°F (-20° – 60°C)
Power:	12VDC, 1.0A



Package Contents

1x Garage Door Controller	1x Tilt Sensor (color may vary)
1x AC/DC Power Adapter	1x 2-Sided Adhesive Tape (Tilt Sensor)
1x Mounting Bracket	2x Mounting Screws
4x Screws, Washers, Wall Anchors	1x Quick Start Guide
2x Hex Bolts, Flat Washers, Split Lock Washers, Nuts	
1x Back Side Mounting 2-Sided Adhesive Tape	

Component Identification

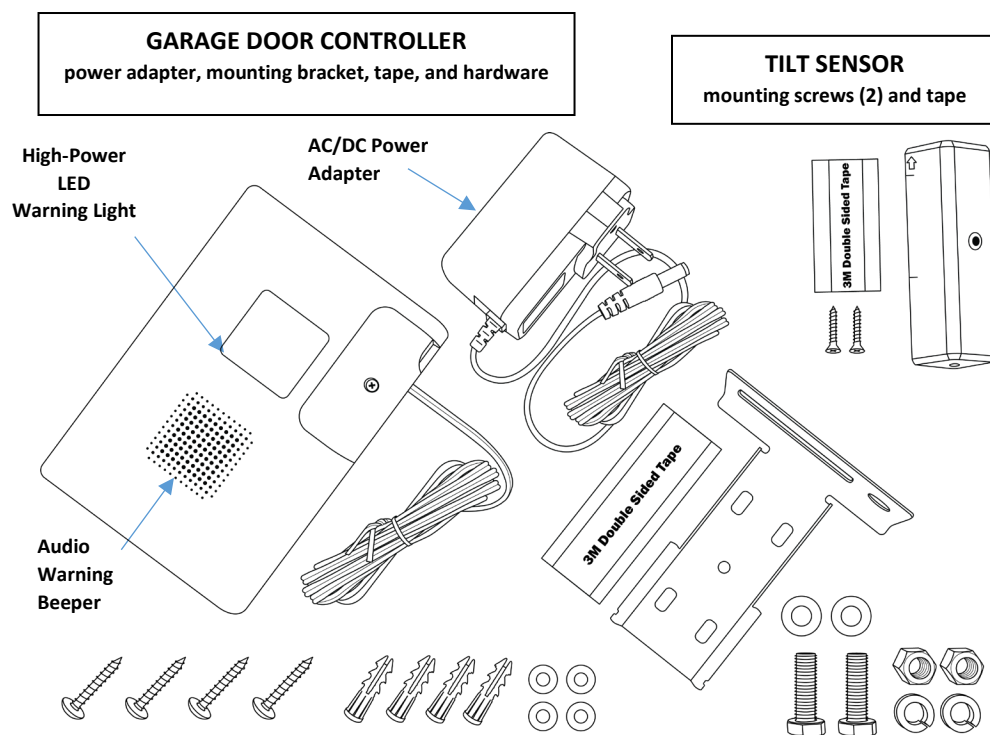

Buttons, Wiring and Status LED:

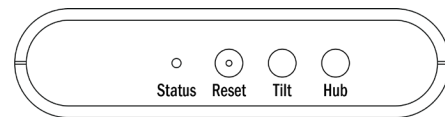

Typical Installation

The Garage Door Controller is pre-paired with a wireless tilt sensor. The Garage Door Controller may ignore commands to control the garage door if it deems that it is unsafe to execute the command.

INSTALLATION OUTLINE:

1. Add Garage Door Controller to a Z-Wave® Network Hub
2. Mount and activate the Tilt Sensor
3. Mount and connect the Garage Door Controller
4. Test system operation

Caution: For safety always temporarily disconnect power from the garage door opener when working near the moving parts.

Step 1: Adding to a Z-Wave® Network

Power up the GDZW7-ECO with the included AC/DC power adapter, and the device's status indicator will blink green twice per second to indicate that the GDZW7-ECO is actively looking to be included into a network.

The GDZW7-ECO must not already be added to a Z-Wave network. If the device was previously added to another Z-Wave network, follow the advanced instructions on removing it from the previous network.

There are a few methods to add a device to a Z-Wave network: SmartStart, Classic and Network Wide Inclusion.

For both methods, you may need to locate the Device Specific Key (DSK) which is on the device's box and on the back side of the device itself. Scan the DSK QR-Code with the panel's or controller's smartphone app or enter it in manually when prompted.

Note: Adding in the device as a long-range node can only be done via SmartStart.

SmartStart:

1. When the GDZW7-ECO is powered up and not included in a network, with the status indicator blinking green twice per second, it is ready for SmartStart.
2. The device may take a few minutes to be added, blinking green rapidly while adding.
3. When it is successfully added, the device will beep and status indicator will illuminate green.

Classic / Network-Wide Inclusion

1. Follow the instructions of the Z-Wave controller to put the Z-Wave controller into manual or classic Z-Wave inclusion mode.
2. Locate and press the "Hub" button on the device.
3. The device will attempt to include itself, with status indicator blinking green rapidly.
4. Be prepared to enter the DSK if asked.
5. When it is successfully added, the device will beep and status indicator will illuminate green.

If the device beeps twice and illuminates yellow 3 seconds, then it was added unsecured, and the device will automatically factory reset itself. This may leave a ghost node on the Z-Wave controller. Follow the Z-Wave controller's instructions to remove the unresponsive node. If the status indicator illuminates red for three seconds the device was NOT added to the network.

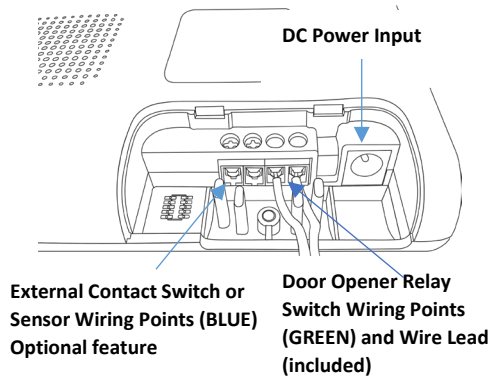

This device also supports Network Wide Inclusion such that the device can be included into the Z-Wave network over the mesh network and not directly near the main controller. This mode is automatically activated after regular inclusion was not successful.

Once the GDZW7-ECO is successfully added to the Z-Wave network, the tilt sensor and the GDZW7-ECO can be mounted.

Step 2: Mount the Tilt Sensor

Activate Tilt Sensor

First, activate the tilt sensor by pulling the battery tab from the Tilt Sensor (or re-installing the battery).

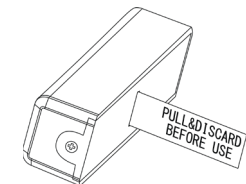

Identify Location for Tilt Sensor:

Choose a mounting method that is appropriate for your garage door. It is very important that the Tilt sensor be located on the top section of a multi-panel garage door. This will be the first section to tilt when the door is opened and the last to move to the vertical position when closing.

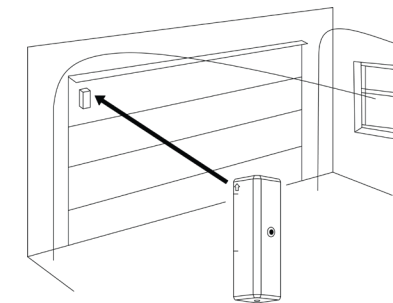

Mount the Tilt Sensor to a clean dry surface WITH THE ARROW ON THE SIDE OF THE SENSOR POINTING UP. The sensor can be mounted using adhesive tape and/or screws.

Caution: Use of the screws is only recommended for garage doors that are thicker than the screws are long. Use only the adhesive tape to mount the tilt sensor for any garage door that is thinner than the length of the provided screws (including many modern metal garage doors).

Step 3: Hard Mount the GDZW7-ECO (Preferred)

Identify Location:

This is the preferred method, if the opener's mounting hardware is sturdy, secure, and there is sufficient space to safely install the GDZW7-ECO. Whenever possible align the front side of the GDZW7-ECO so it generally faces the Hub or Panel with which it is paired.

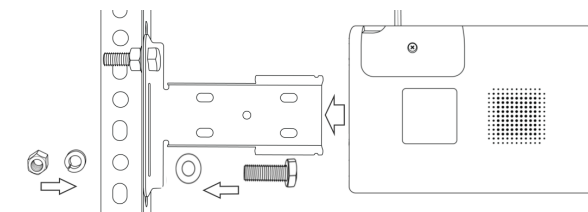

Using the included mounting bracket and two sets of hex head bolts, flat washers, split lock washers and nuts, affix the bracket to the garage door opener's mounting hardware. Then align the slots on the back of the GDZW7-ECO with the bracket, and slide until it snaps in place for a secure hold.

Ceiling Mount the GDZW7-ECO (Option 2)

Identify Location:

The GDZW7-ECO placement should be on the ceiling within 6 inches from the points where the garage door opener is mounted to the ceiling, so opener operation can be detected.

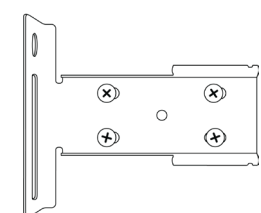

Mount the GDZW7-ECO on the ceiling near the garage door opener and the power outlet using the included mounting bracket and four sets of screws, washers, and plastic anchors.

Direct Mount the GDZW7-ECO (Option 3)

Alternatively, if hard-mount and ceiling mount are not practical the GDZW7-ECO can be mounted directly on the garage door opener using the large foam tape strip. Prepare a flat surface on the garage door opener body, ensuring it is clean and dry for proper tape adhesion. Affix the foam tape to the recessed area in the center of the back face of the GDZW7-ECO. Then press and hold the GDZW7-ECO against the prepared area on the garage door opener, compressing the tape for 30 seconds. Note: This direct-mount method does not meet the UL 325 standard.

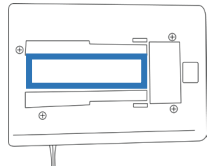

Connect GDZW7-ECO to Power

Remove the screw from the 120 VAC outlet near the garage door opener and use it to secure the included power adapter for the GDZW7-ECO.

Route and secure the power lead, then plug the DC connector into the GDZW7-ECO. The status LED on the GDZW7-ECO will illuminate solid green upon powerup, if already added to the Z-Wave network.

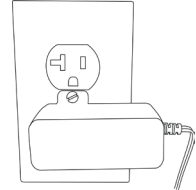

Connect GDZW7-ECO to Opener Motor

Determine your opener type.* Use wireless control for garage door openers with Chamberlain® Security+ 2.0 (yellow learn button) and Chamberlain Security+ (purple, red, or orange learn buttons). For all other garage door openers use the Wired option below.

Wireless

To learn the GDZW7-ECO into the garage door opener like a wireless remote:

1. Plug the garage door opener power cord back into the 120 VAC outlet.
2. To switch between Security+ 2.0 and Security+ modes on GDZW7-ECO, press and hold the HUB button for two (2) seconds. The GDZW7-ECO speaker will beep twice, and the Status LED will blink twice in Security+ 2.0 mode, or only beep/blink once if in Security+ mode. Repeat until in the desired mode.
3. Press the pairing button on the back of the Garage Door Opener motor and check if a status LED indicates pairing mode.*
4. Press and hold the TILT button on the GDZW7-ECO for two seconds. The speaker should beep twice, and the GDZW7-ECO will transmit like a remote.
5. Check the Garage Door Opener status LED is no longer in Pairing mode.*
6. To test the pairing, press and hold TILT button on the GDZW7-ECO for two seconds. If pairing was successful, the garage door opener will start to move.
7. Repeat steps 2 – 6, as needed.

Wired

1. Connect the GDZW7-ECO’s relay switch wires to the pushbutton wall console terminals on the garage door opener. Make sure not to disconnect any wires that are already connected to the garage door opener. The terminal location and labels will vary by model, but may be named: **“PUSHBUTTON”, “WC”, “PWC”, “PB”**.*
2. Plug the garage door opener power cord back into the 120 VAC outlet.

Test System Operation

Caution: Be sure the GDZW7-ECO and its wires are clear of all moving parts, and the Warning Light is **not** obstructed. Adjust the installation and secure the wires, if needed.

1. To verify normal operation and calibrate the GDZW7-ECO’s sensors, first use the garage door opener’s manual push button to open, then close, the garage door.
2. Now use your Z-Wave® controller to OPEN the garage door.
3. For the final test, use your Z-Wave controller to CLOSE the garage door. The LED Warning Light will repeatedly flash, and the audio beeper will repeatedly beep while the garage door closes.

* Refer to the manual for the garage door opener to see specific instructions for that model.

Advanced Installation Options

The GDZW7-ECO has additional installation options.

Removal from a Z-Wave® Network

There are two methods to removing the GDZW7-ECO from a Z-Wave network: exclusion and performing a factory reset (see section on Factory Reset).

1. Follow the Z-Wave controller’s instructions on putting the Z-Wave controller into removal/exclusion mode.
2. Locate and press the hub button.
3. Device’s status indicator will blink red and beep three times to indicate successful removal.

Factory Reset

Please use this procedure only when the network primary controller is missing or otherwise inoperable. Factory resetting the GDZW7-ECO will default it to factory settings and reset the tilt sensor pairing to the original tilt sensor.

1. Locate the reset button.
2. Insert a paperclip into the hole until you feel the button depress. There will be a short beep.
3. Hold the button down for ten seconds. The status indicator will blink red while the reset button is pressed and will go out after ten seconds.
4. The device’s status indicator will turn green when the reset operation is complete. The device is now ready to be added to a Z-Wave network.

Note: Factory reset only works when the device is already added into a Z-Wave network. If the GDZW7-ECO is not included in a network, then it cannot be factory reset.

Adding a Tilt Sensor

The GDZW7-ECO pairs with the tilt sensor to monitor the state of the garage door. **The original (included with the GDZW7-ECO) tilt sensor does not need to be added.** To add a different Ecolink ClearSky tilt sensor:

1. Locate and press the “Tilt” button. There will be a short beep and LED will blink red.
2. Remove pull-tab from the tilt sensor or reinsert the battery into the tilt sensor.
3. If pairing is successful, the warning light will blink white and beep for one second.

Adjust the Tilt Sensor Angle

To adjust the angle at which the tilt sensor detects an open or close, manually bend the ball-in-can as shown. By slightly bending this can up and down, there is a slight adjustability of ± 10°.

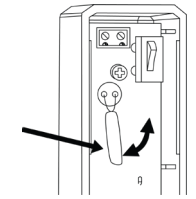

Change the Tilt Sensor’s Battery

Use a screwdriver to remove the screw on the bottom of the sensor case. Push against and outwards where the screw was located, and the case will open. Replace with a fresh CR123A battery. Fit the case back together and screw the case shut.

Adding an External Contact Switch or Sensor

Alternatively, the GDZW7-ECO can pair with an external contact to monitor the state of the garage door. If connected and added the external contact will be used **instead** of a tilt sensor.

To add a hardwired external contact:

1. Connect external contact’s wires to the GDZW7-ECO’s blue terminal block.
2. Locate and press the tilt button. There will be a short beep and the status LED will blink red.
3. Trigger the external contact to the “open” state.
4. If pairing is successful, the warning light will blink white and beep for one second.

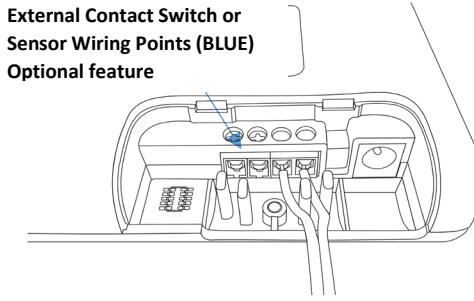

Troubleshooting

Problem	Possible Cause	Solution
Unable to add device to Z-Wave network	Device was not properly excluded from a previous Z-Wave network	Try removing the device by putting the Z-Wave controller into exclusion mode and then pressing the GDZW7-ECO’s Hub button. You can also factory reset the device in the case of a missing or inoperative Z-Wave controller.
Z-Wave open/close commands don’t do anything and warning lights flashes 3 times	One of the following: - Tilt sensor is lost - Tilt sensor is tampered - Tilt sensor count out of sync - Previous close/open operation timed out	Make sure the tilt sensor has a good battery and the covering is properly closed. For all other causes, manually operate the garage door opener via the push-button wall console to resync the tilt sensor and GDZW7-ECO.
Device flashes and beeps during the unattended wait period, but the door does not move	Device detected a vibration during the unattended wait period and cancelled the original close command.	Send the close command again. If this is a recurring issue, consider lowering the accelerometer sensitivity (Configuration Parameter #5)
Device’s relay switch is activated, but the door does not move	Incorrect wiring	Make sure the relay switch wires are connected to the correct terminals on the garage door opener terminal. They should be connected to the garage door opener’s push-button wall console terminals. Do not disconnect any wires from the garage door opener.

FCC Compliance Statement

FCC ID: XQC-GDZW7LR IC ID: 9863B-GDZW7LR

This device complies with part 15 of the FCC Rules. Operation is subject to the following two conditions: (1) This device may not cause harmful interference, and (2) this device must accept any interference received, including interference that may cause undesired operation. This equipment has been tested and found to comply with the limits for Class B digital devices, pursuant to Part 15 of the FCC Rules. These limits are designed to provide reasonable protection against harmful interference in a residential installation. This equipment generates uses and can radiate radio frequency energy and, if not installed and used in accordance with the instruction manual, may cause harmful interference to radio communications. However, there is no guarantee that interference will not occur in a particular installation. If this equipment does cause harmful interference to radio or television reception, which can be determined by turning the equipment off and on, the user is encouraged to try to correct the interference by one or more of the following measures:

- Re-orient or relocate the receiving antenna
- Increase the separation between the equipment and receiver
- Connect the equipment to an outlet on a different circuit from the receiver
- Consult the dealer or an experienced radio/TV contractor for help.

Warning: Changes or modifications not expressly approved by Ecolink Intelligent Technology Inc. could void the user’s authority to operate the equipment.

IC Compliance Statement

This device complies with Industry Canada licence-exempt RSS standard(s). Operation is subject to the following two conditions: (1) this device may not cause interference, and (2) this device must accept any interference, including interference that may cause undesired operation of the device.

C’et appareil est conforme la norme d’Industrie Canada exempts de licence RSS. Son fonctionnement est soumis aux deux conditions suivantes: (1) c’et appareil ne peut pas provoquer d’interférences, et (2) c’et appareil doit accepter toute interférence, y compris les interférences qui peuvent causer un mauvais fonctionnement de la dispositif.

Trademarks

Chamberlain is a registered trademark of The Chamberlain Group LLC. Z-Wave is a registered trademark of Z-Wave Alliance Inc. All trademarks, logos and brand names are the property of their respective owners. All company, product and service names used in this document are for identification purposes only. Use of these names, trademarks and brands does not imply endorsement.

Warranty

Ecolink Intelligent Technology Inc. warrants that for a period of 1 year from the date of purchase that this product is free from defects in material and workmanship. This warranty does not apply to damage caused by shipping or handling, or damage caused by accident, abuse, misuse, misapplication, ordinary wear, improper maintenance, failure to follow instructions or as a result of any unauthorized modifications.

If there is a defect in materials and workmanship under normal use within the warranty period Ecolink Intelligent Technology Inc. shall, at its option, repair or replace the defective equipment upon return of the equipment to the original point of purchase.

The foregoing warranty shall apply only to the original buyer, and is and shall be in lieu of any and all other warranties, whether expressed or implied and of all other obligations or liabilities on the part of Ecolink Intelligent Technology Inc. neither assumes responsibility for, nor authorizes any other person purporting to act on its behalf to modify or to change this warranty, nor to assume for it any other warranty or liability concerning this product. The maximum liability for Ecolink Intelligent Technology Inc. under all circumstances for any warranty issue shall be limited to a replacement of the defective product. It is recommended that the customer check their equipment on a regular basis for proper operation.